



COW **SHED**

**FIRST LIFE, THEN SPACES, THEN BUILDINGS-  
THE OTHER WAY AROUND NEVER WORKS**

JAN GEHL

# SITE LOCATION

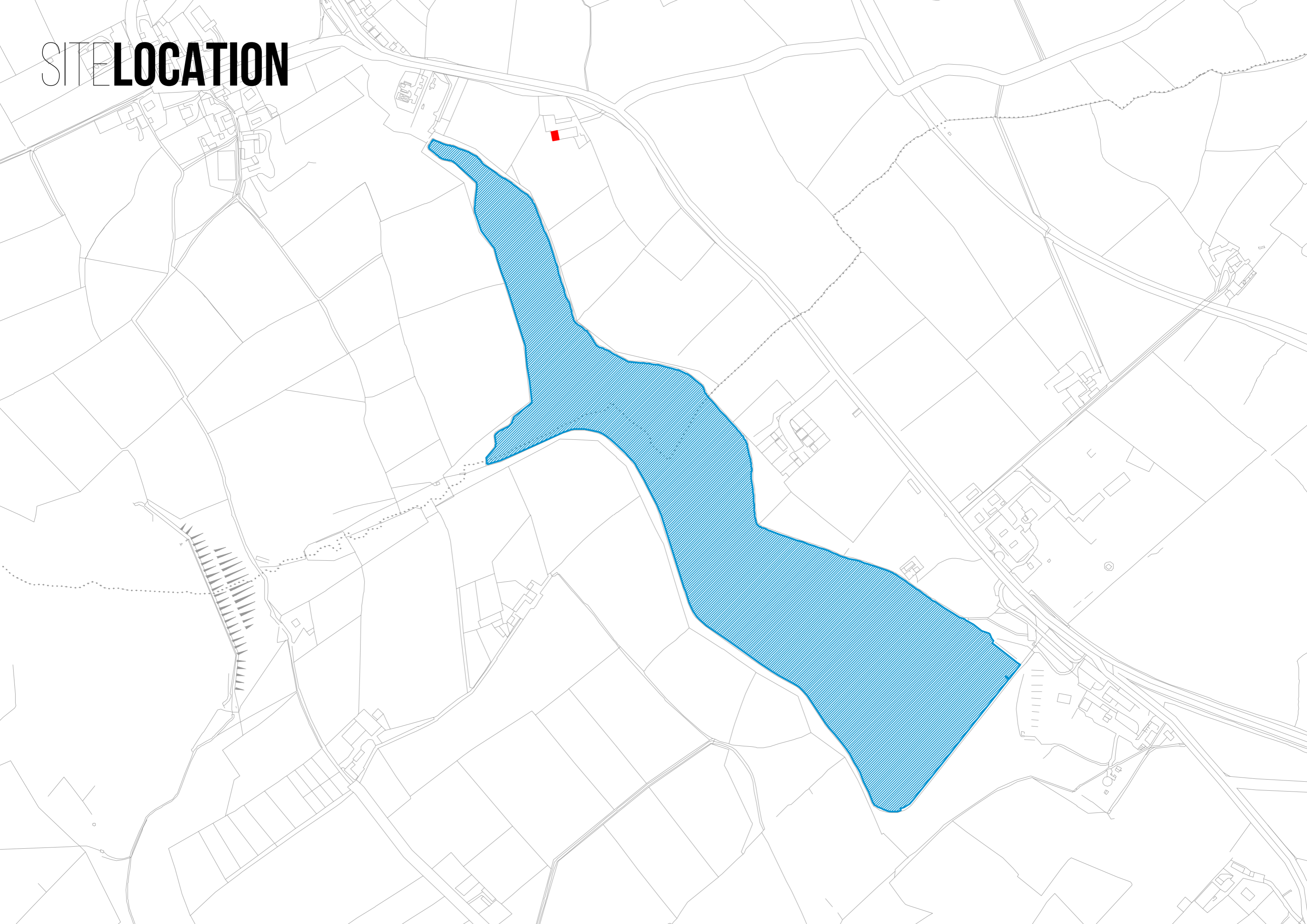

# SITE SPECIFIC

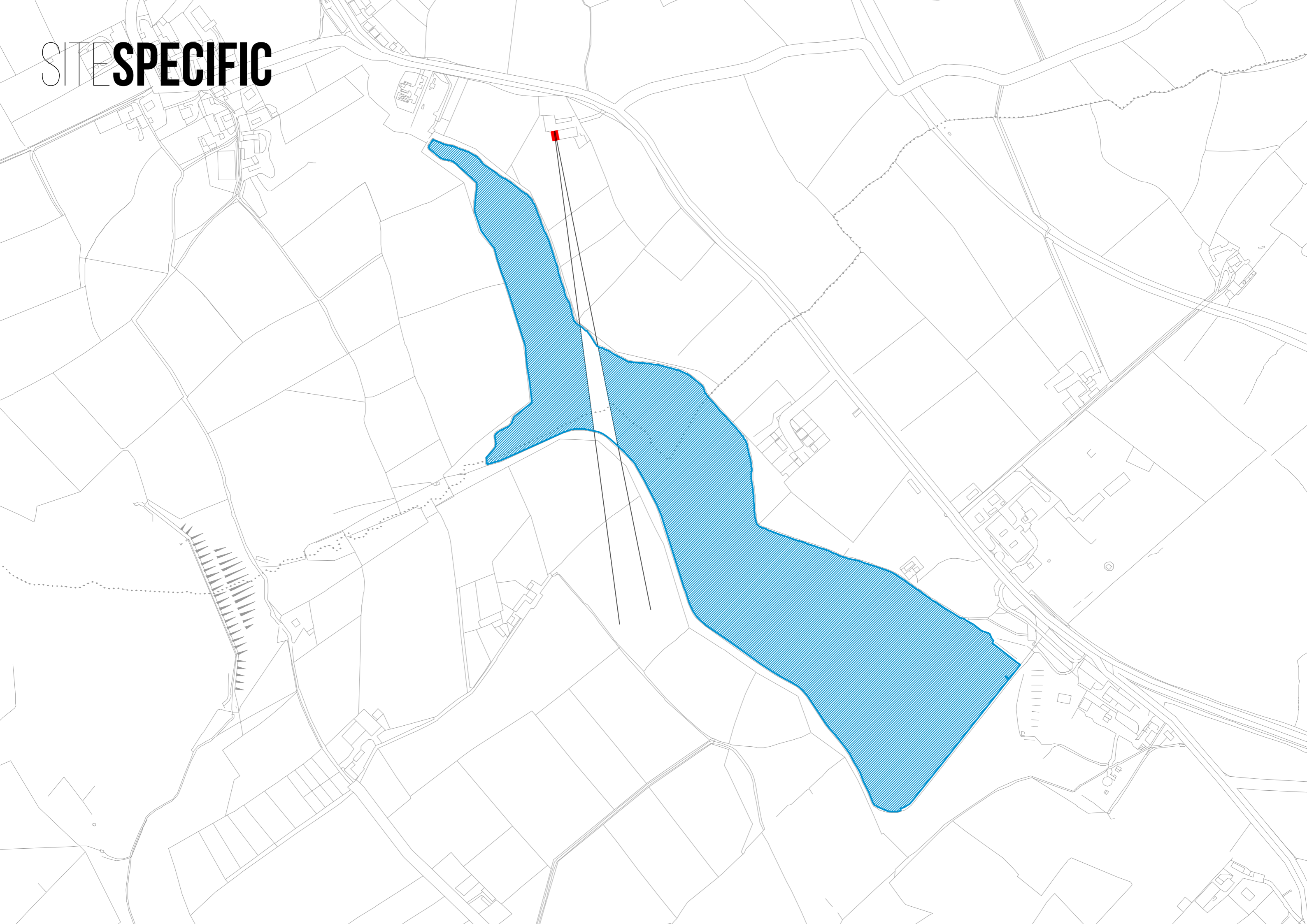

MASSING**SHED**

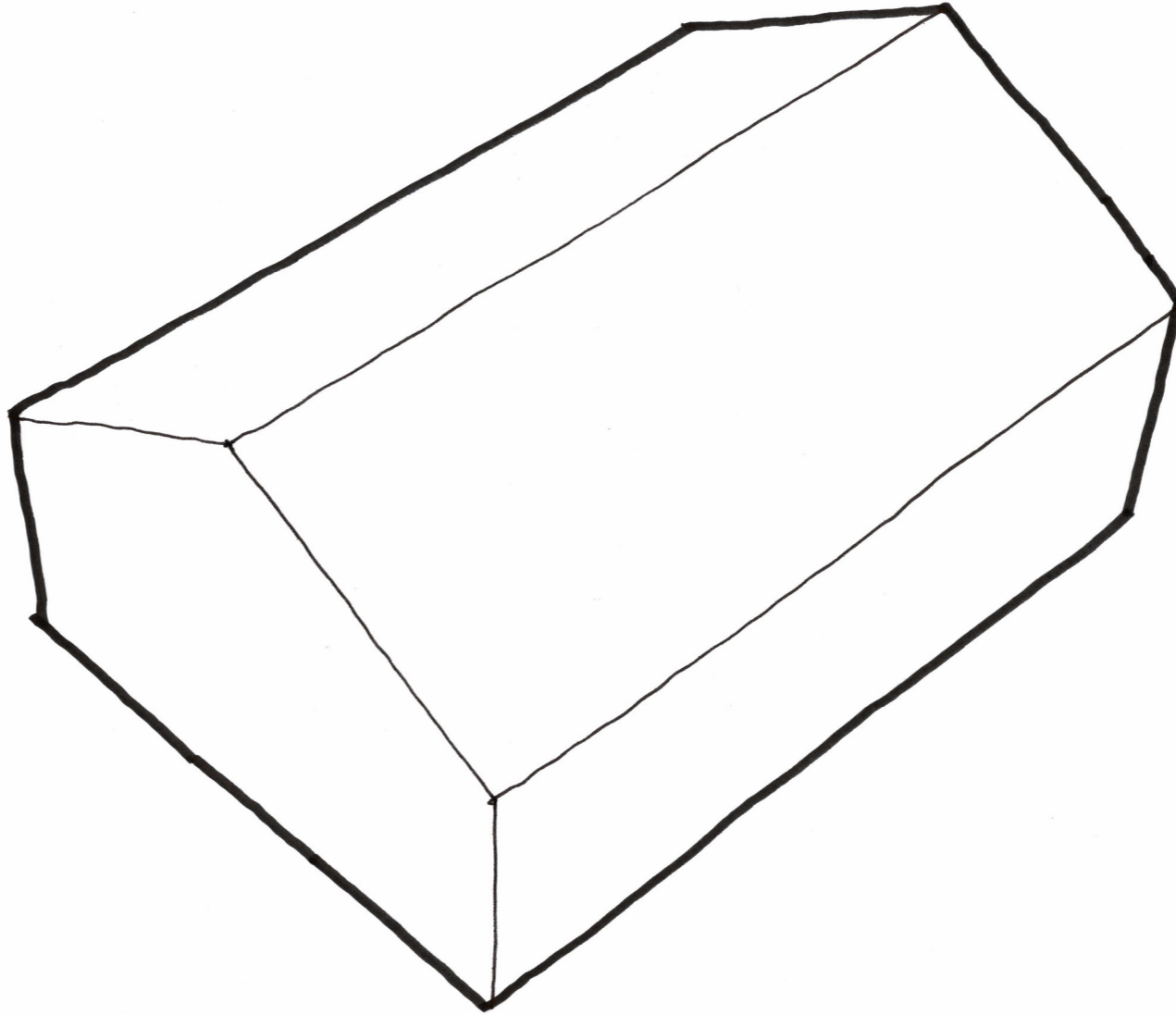

# MASSING **VIEWS**

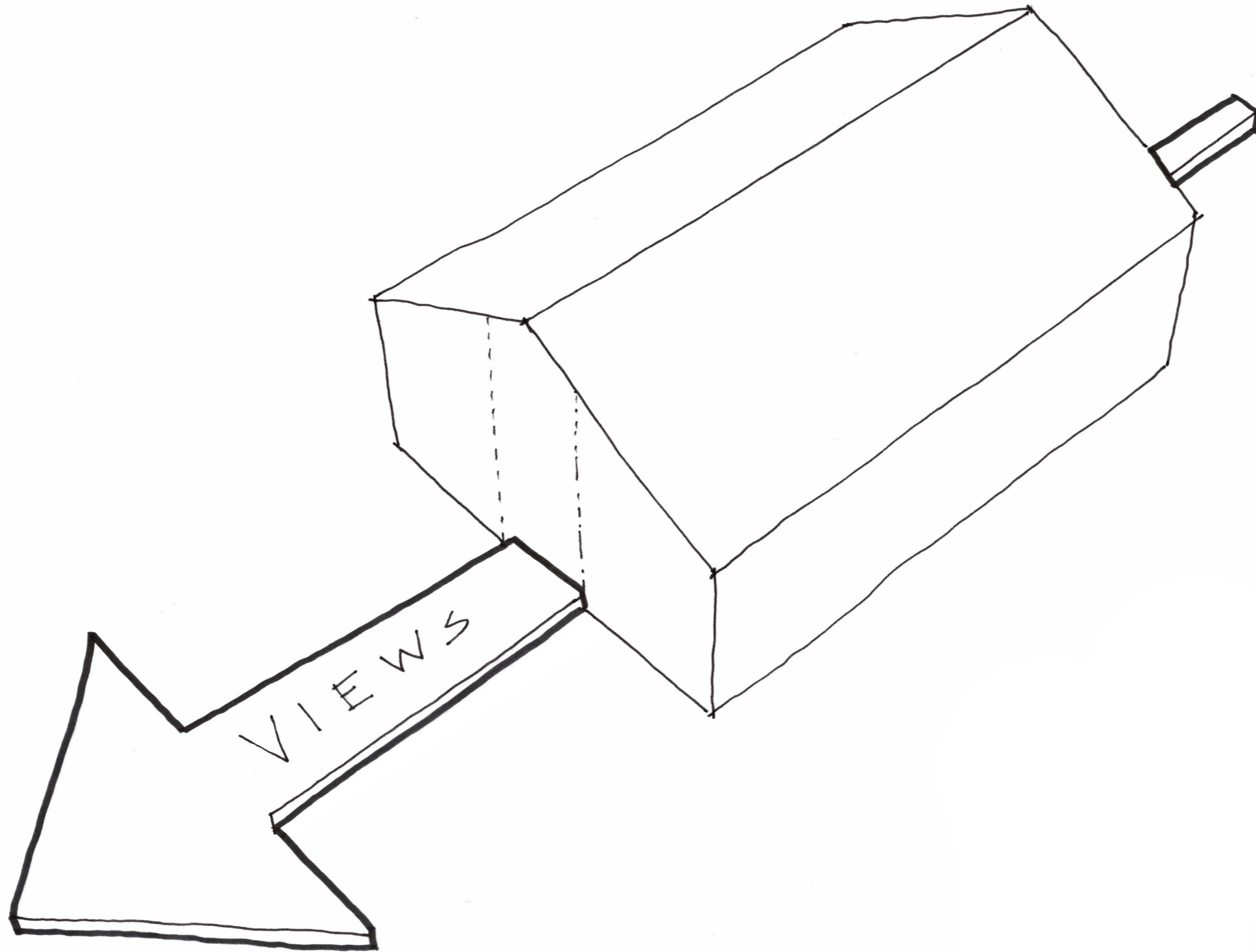

# MASSING **SOLID/VOID**

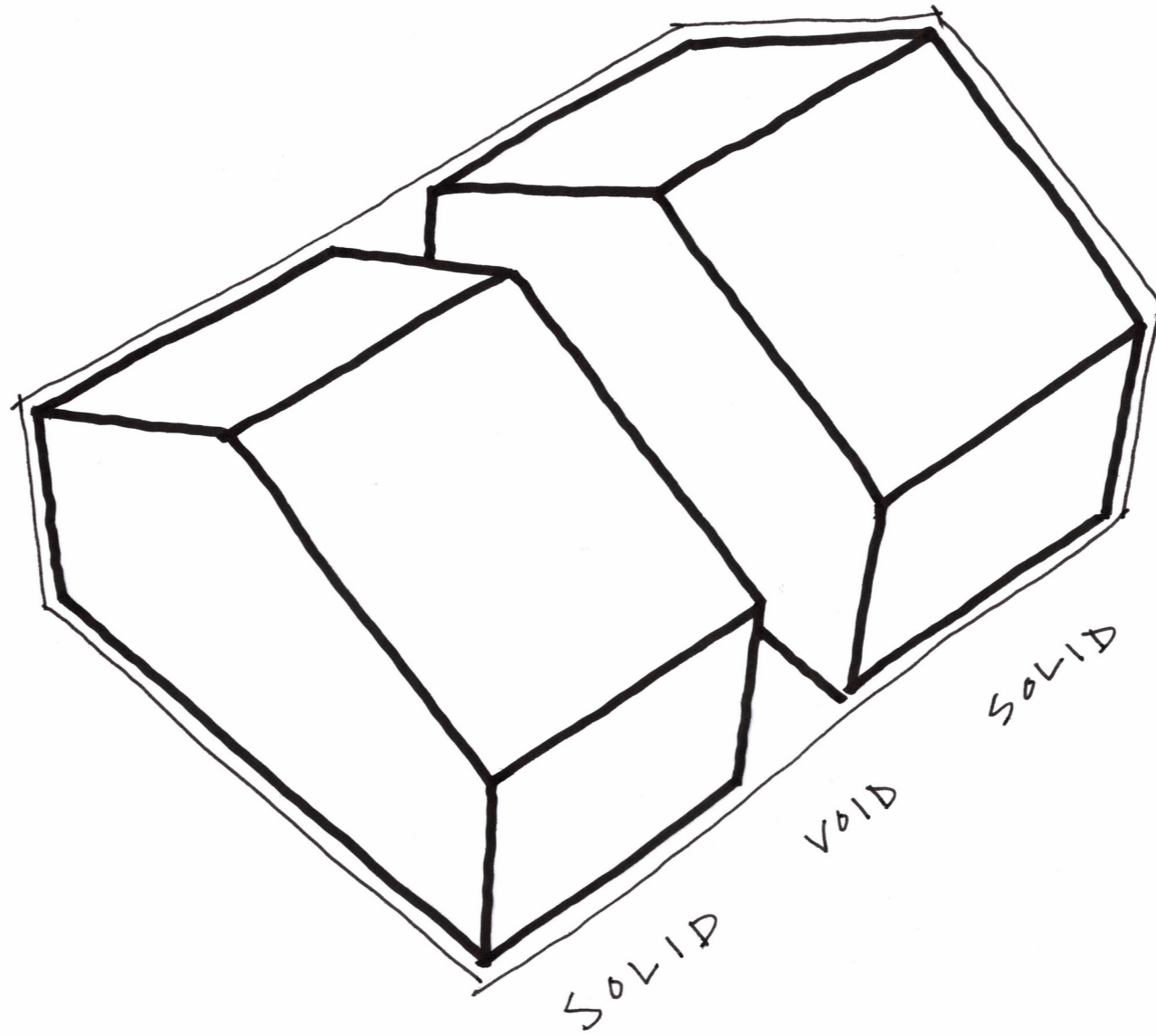



# MASSING **BRIDGE**

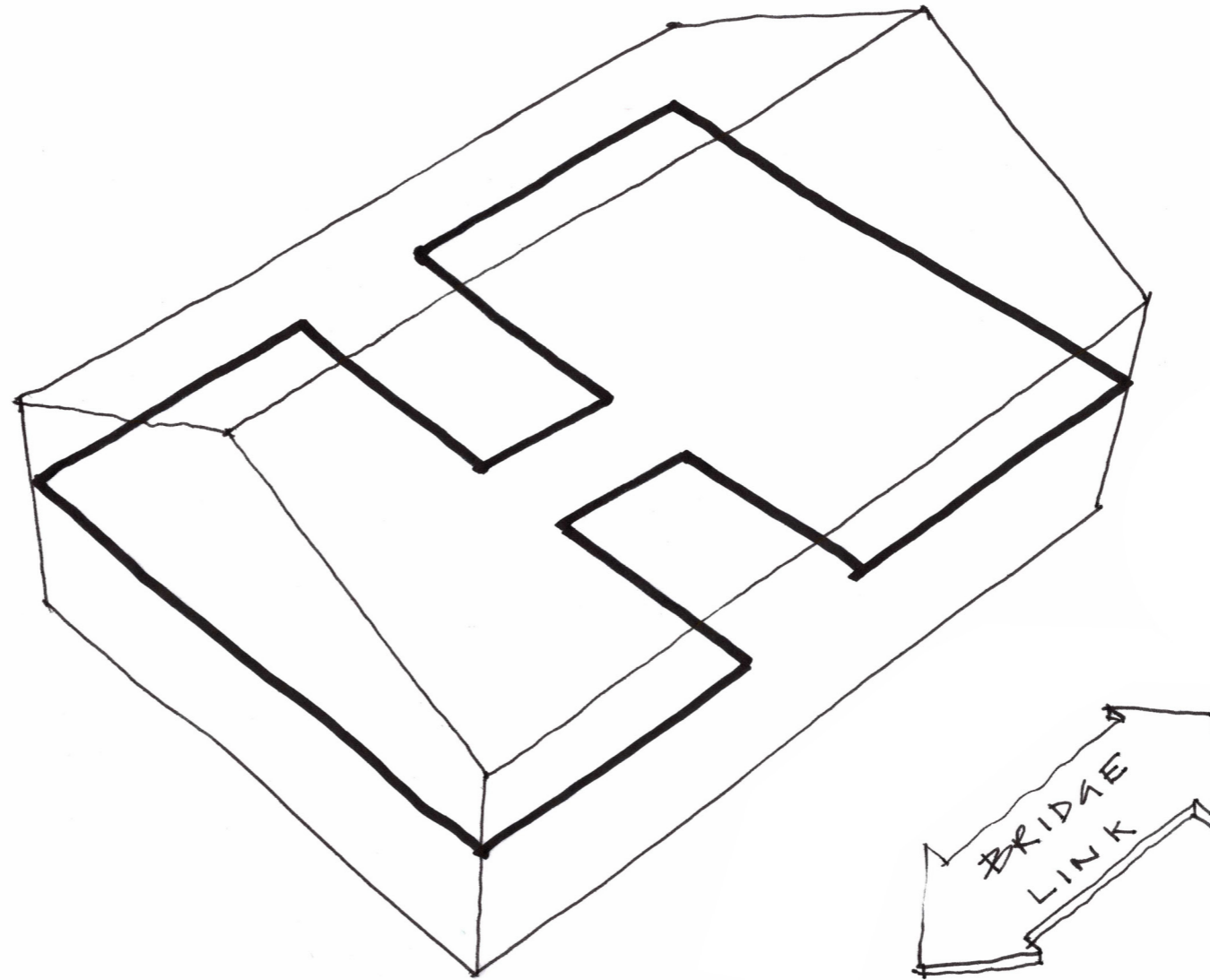

# MASSING **MEZZANINE**

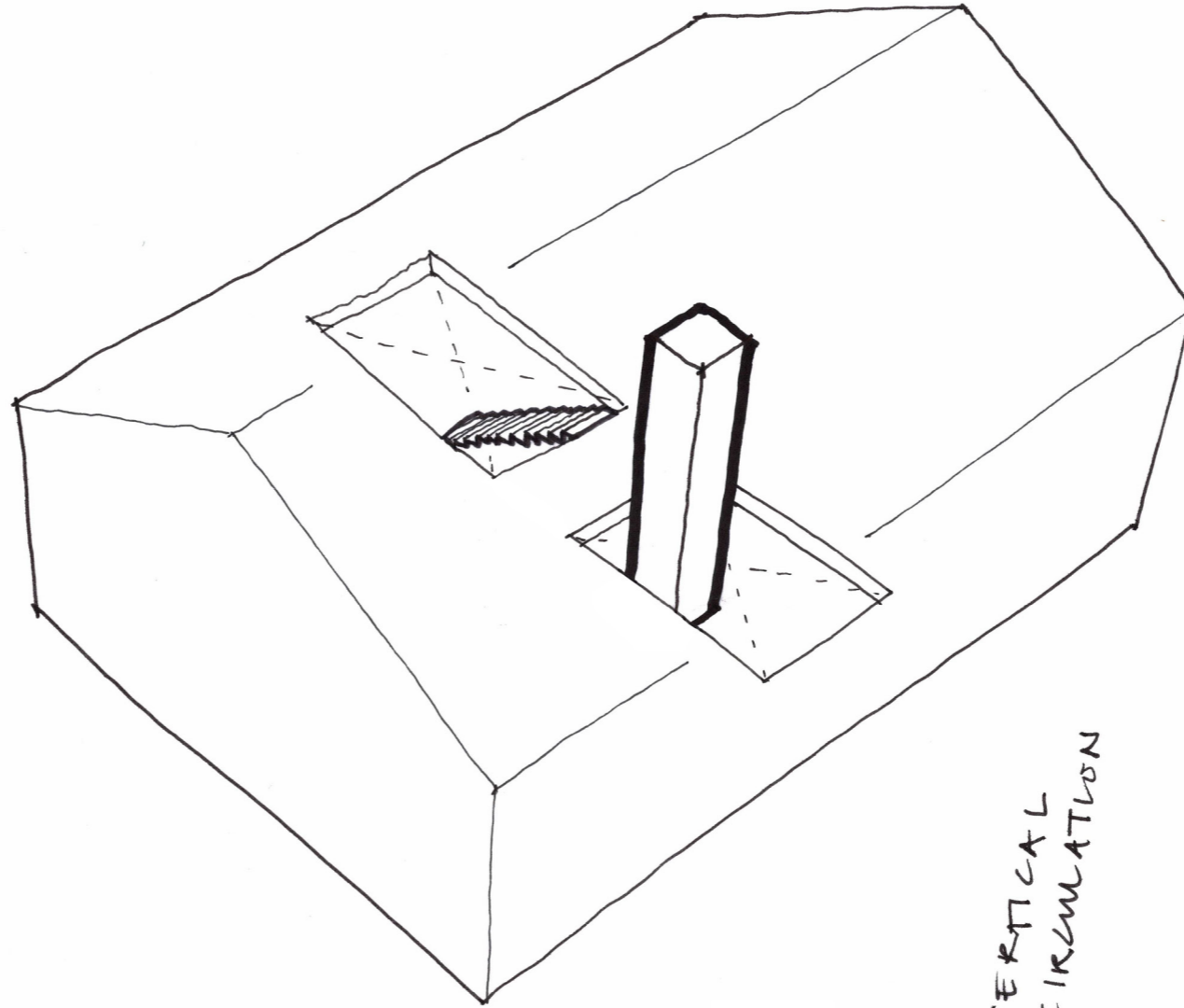

VERTICAL  
CIRCULATION

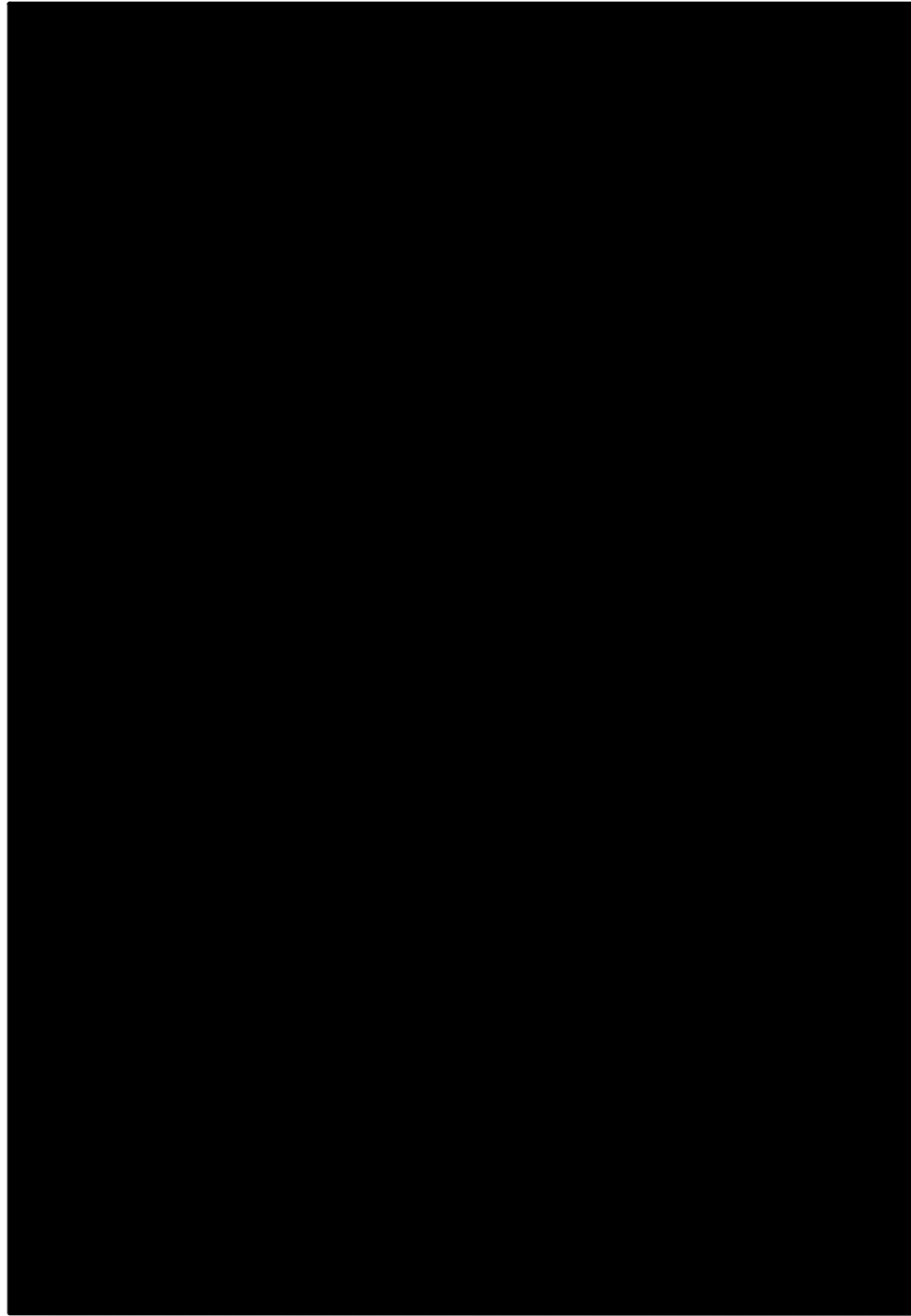

# PLAN **AXIS**

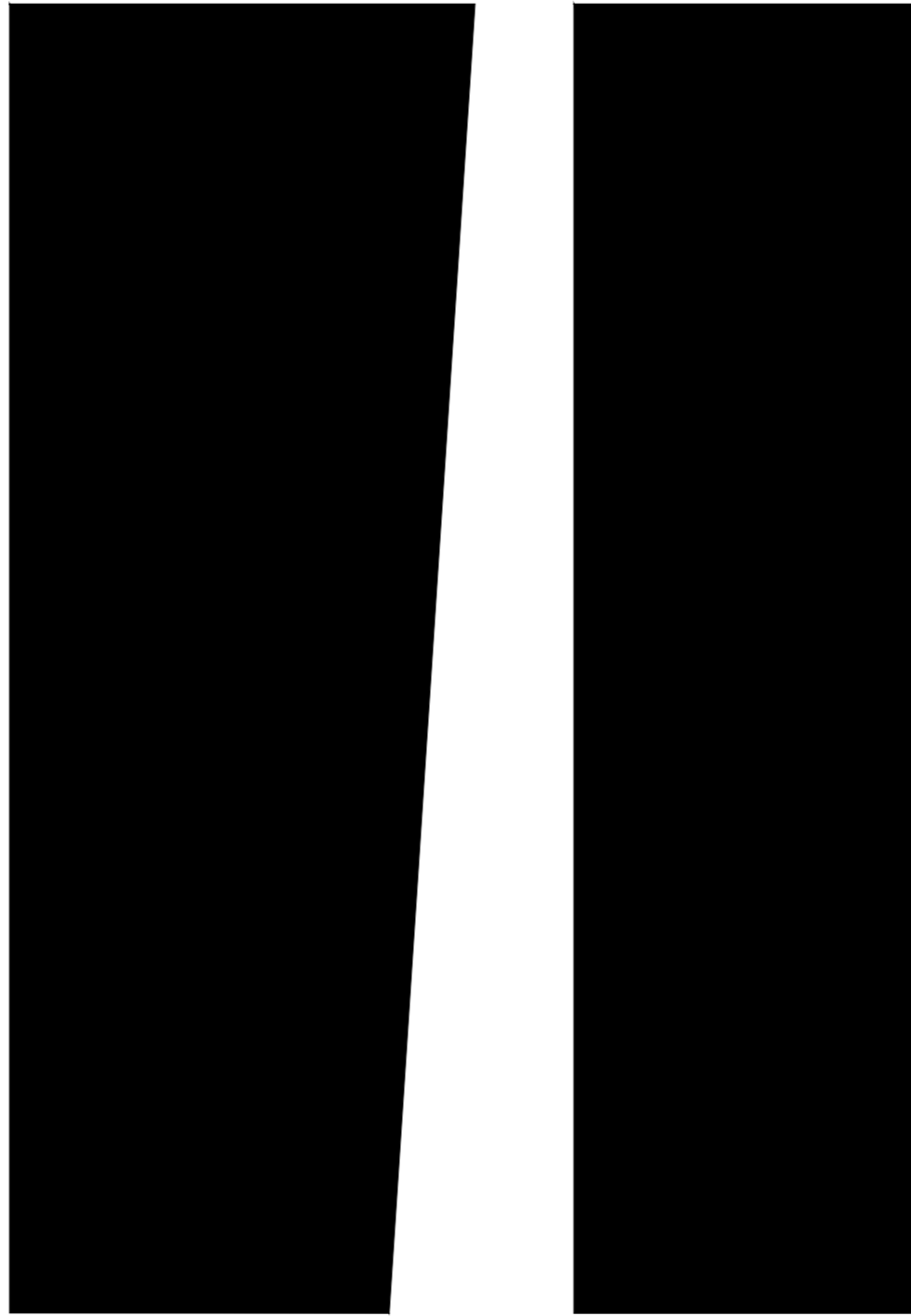

VIEWS

# PLANGROUND

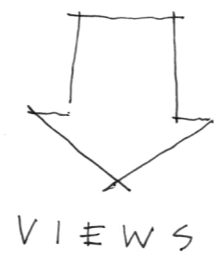
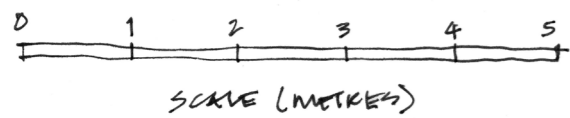
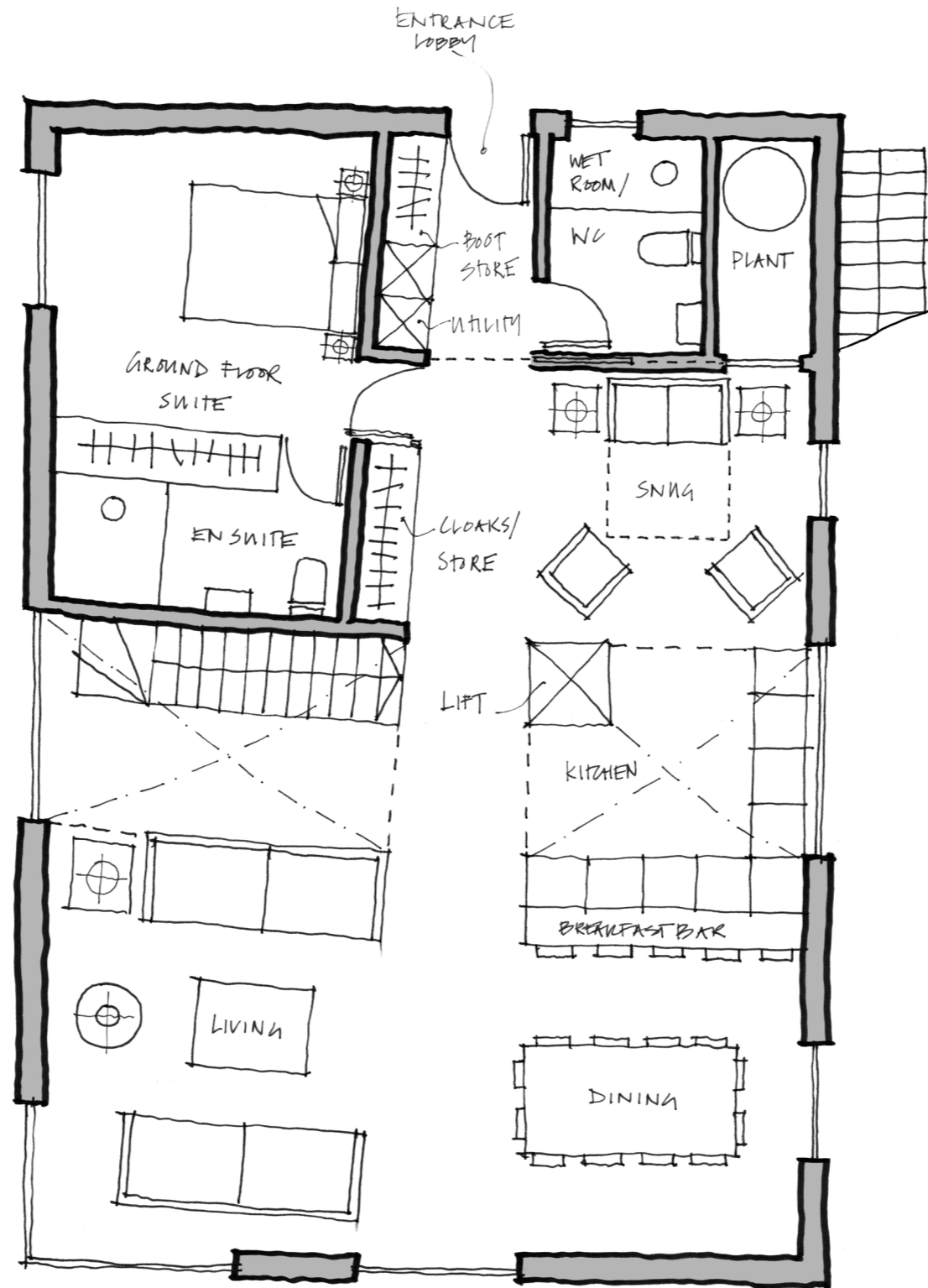

# PLAN FIRST

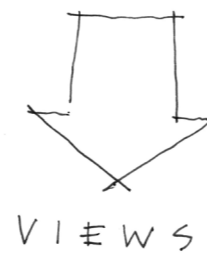
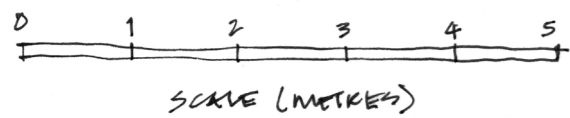
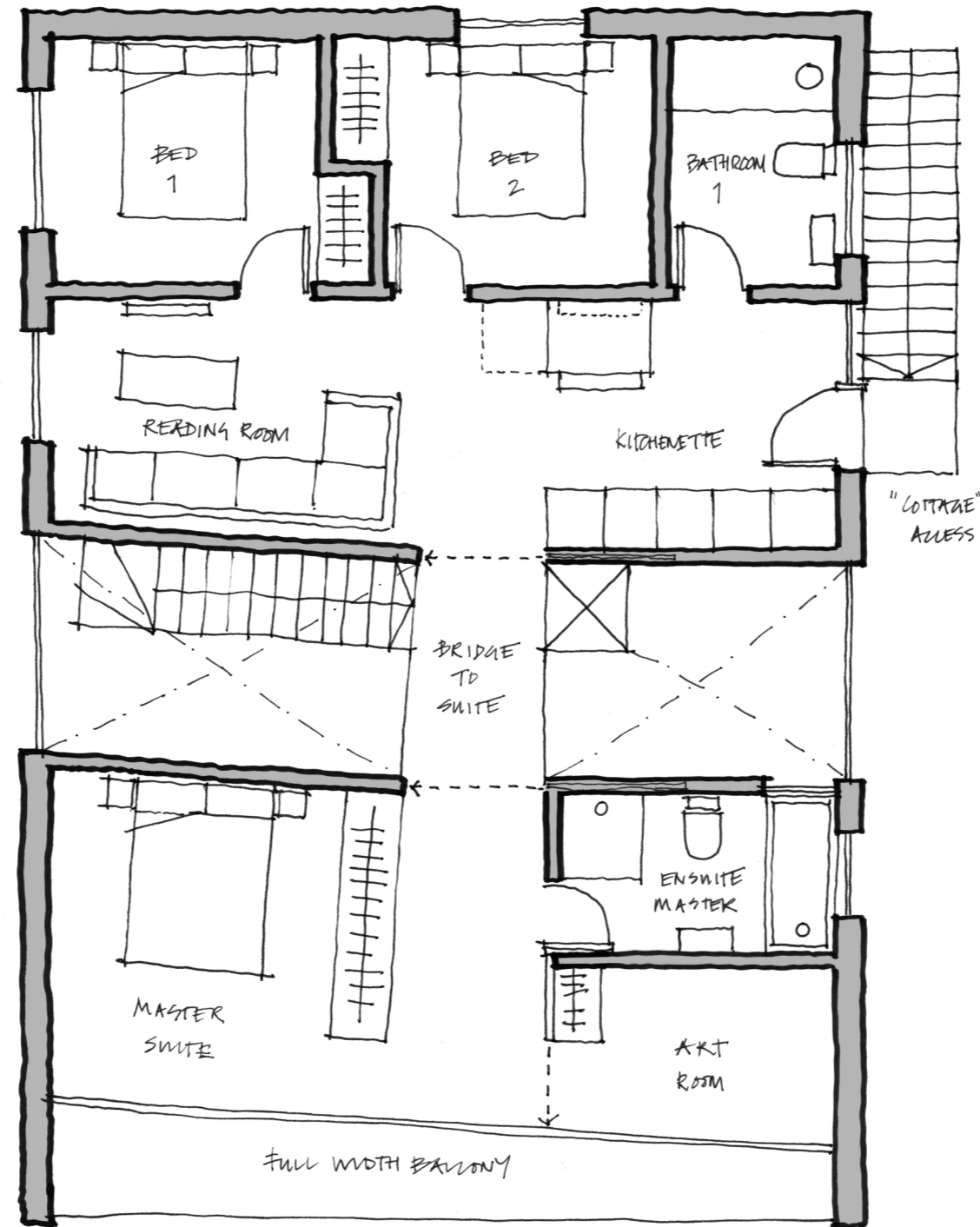

# PLAN AIRBNB

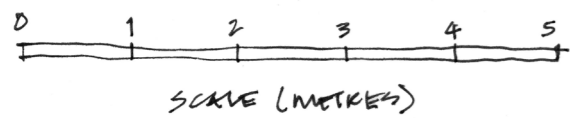
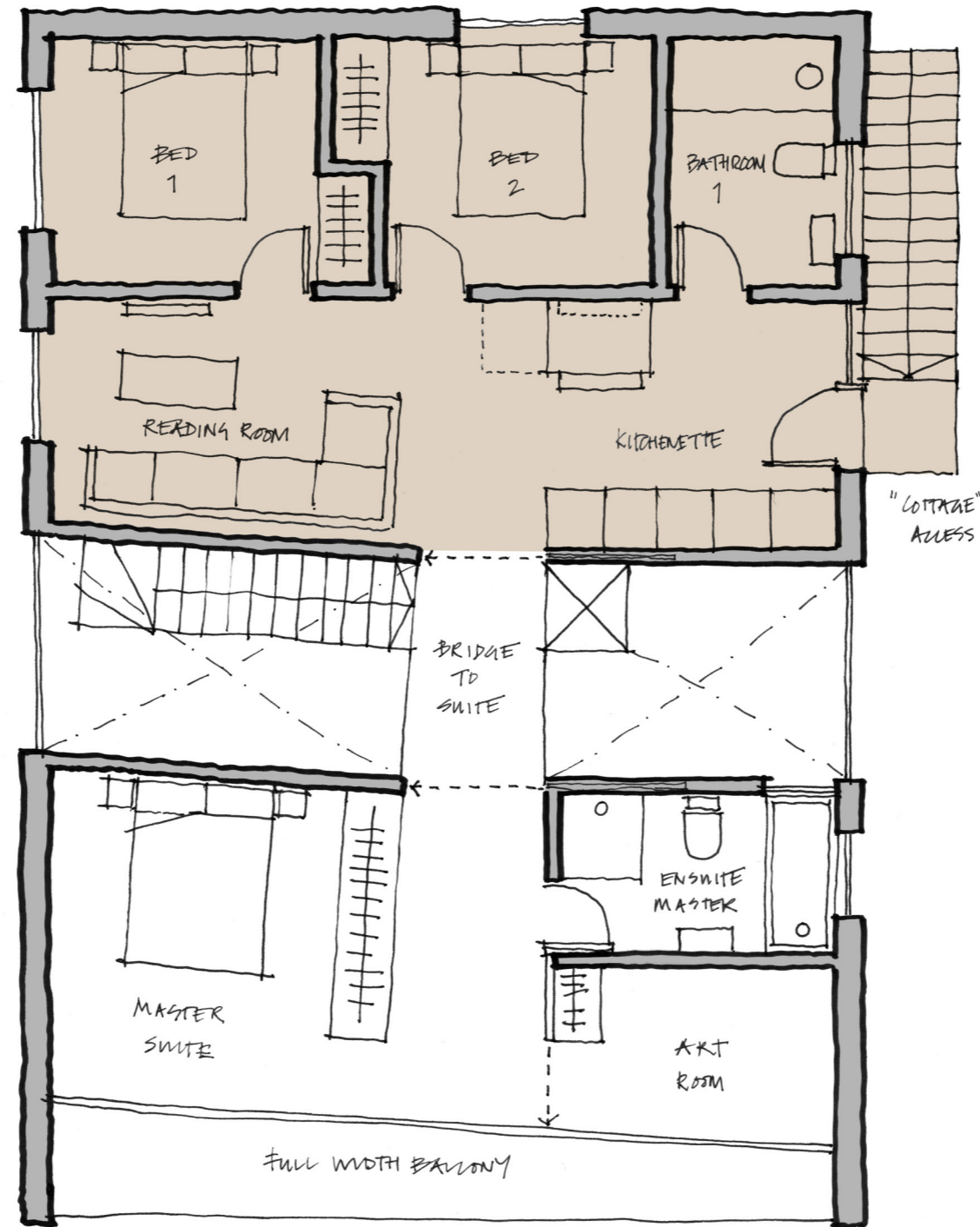

# PRECEDENT **STAIR**

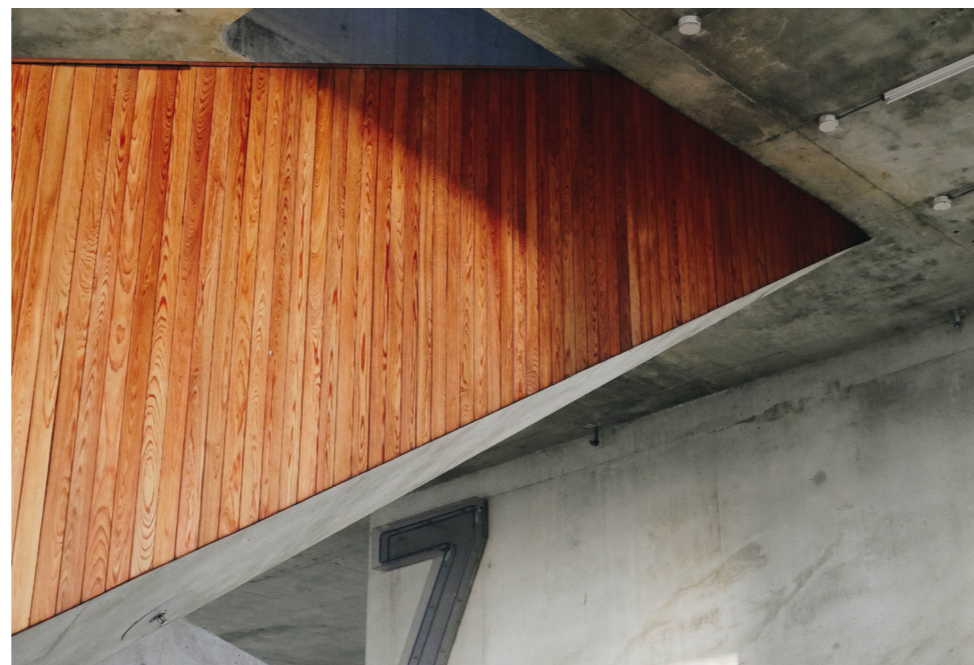
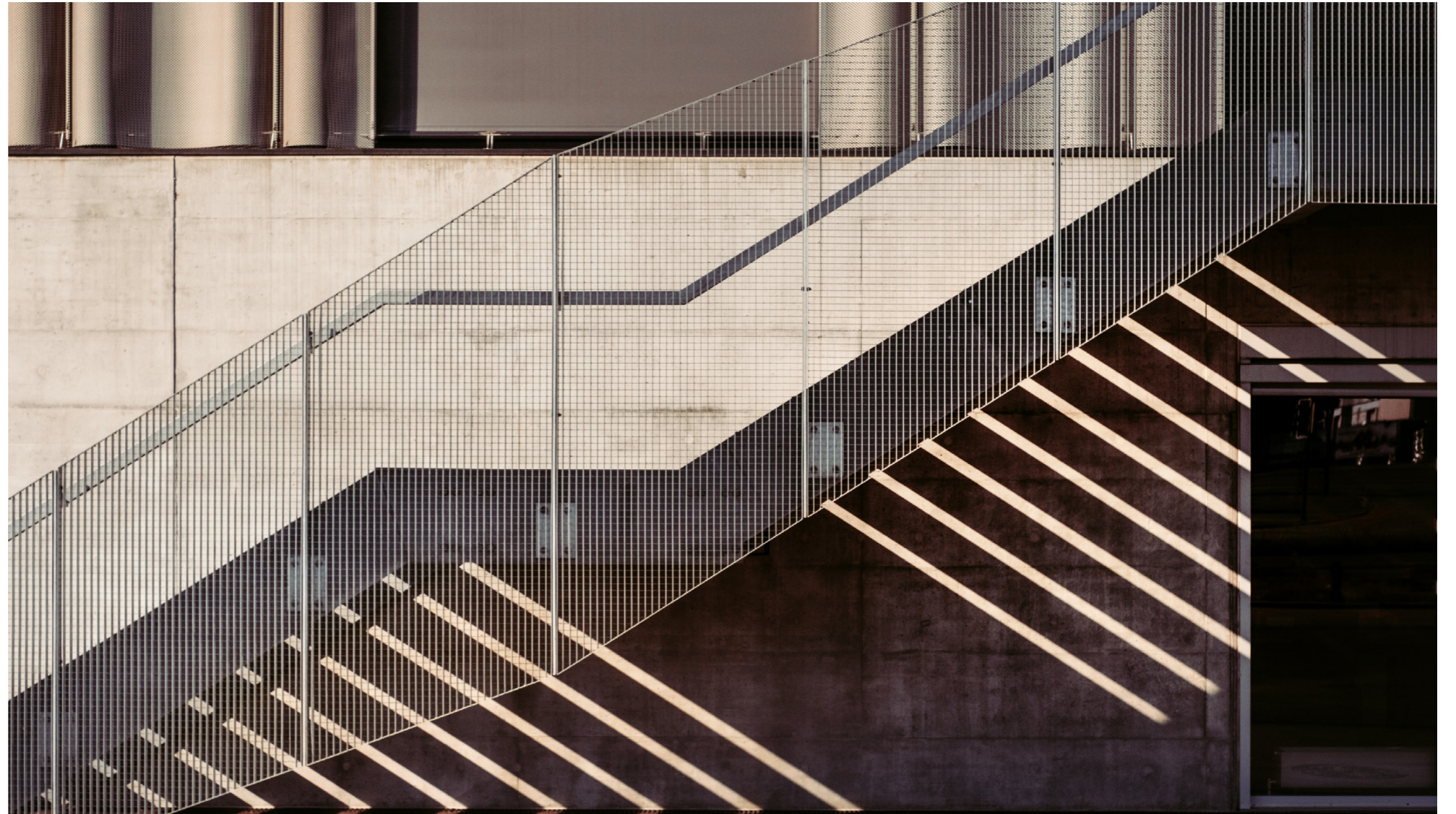



# PRECEDENT **LIFT**

